

HFG9

The High Efficiency Generator

Copyright 2003 Creative Science & Research

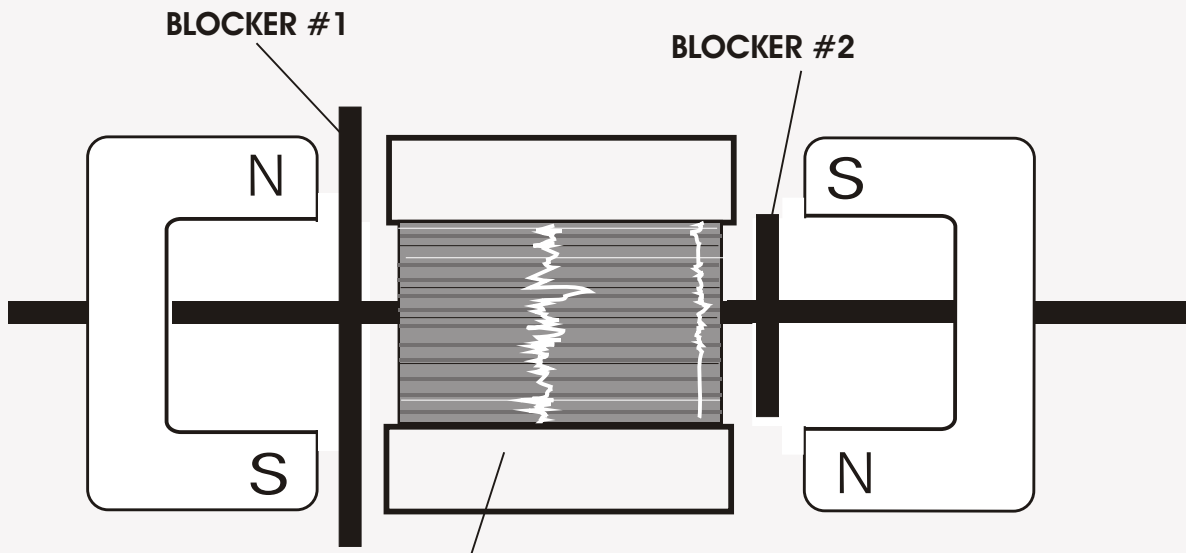

**COIL with 1,000s of wraps #30 or #22
copper coated wire with soft iron core
or you can use Ductal # 65-4512**

Use Very Powerful Ceramic Magnets, Horse Shoe or Bars

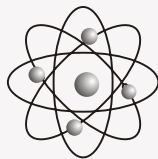

**CREATIVE SCIENCE
& RESEARCH**

P.O. BOX 557 NEW ALBANY, IN. 47150

(812) 945-5839

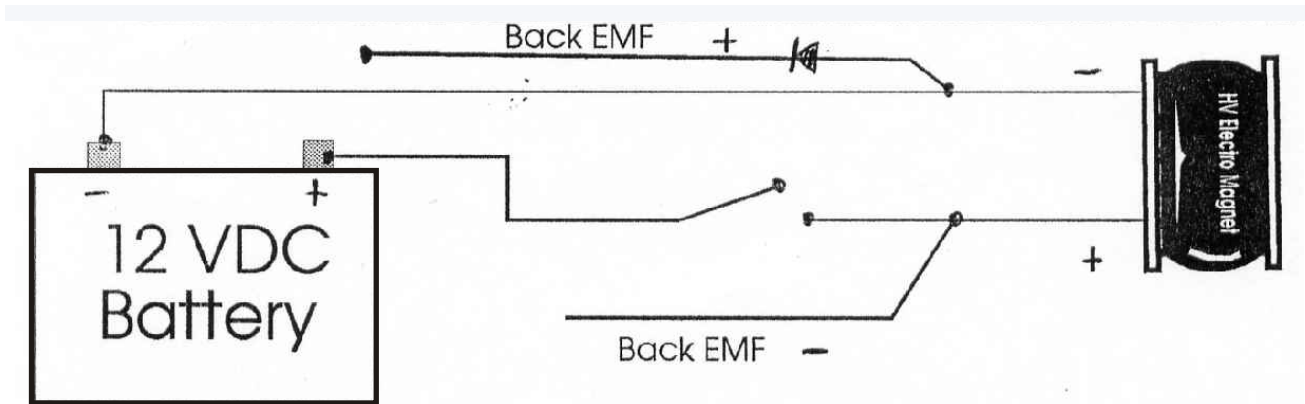

FREE ENERGY FROM A COLLAPSING MAGNETIC FIELD!

Collecting the back EMF from a motor coil or generator coil. Back Emf is free energy from a collapsing magnetic field generated in a coil of copper coated wire and collected to store or to apply back into the working apparatus or batteries.

So how do you collect the back EMF?

Lets start with the basic's. We start with a coil of copper coated wire which is used as an electromagnet or a generator coil. By applying 12 volts DC to the coil of wire you get a strong magnetic field, Polarity is forward and when that 12 vdc is turned off the coil produces a reversed polarity, in which the magnetic field changes also. But voltage will be lower because the 12 VDC must be pulsed (Switched on & off) at a high rate. The faster the better, So what is happening is you are getting FREE ENERGY FROM A COLLAPSING MAGNETIC FIELD. SEE fig, #1 You will need to use a diode to capture the back Emf.

The High Efficiency Generator # Hfg9

Copyright 1996 - 2003 Creative Science & Research

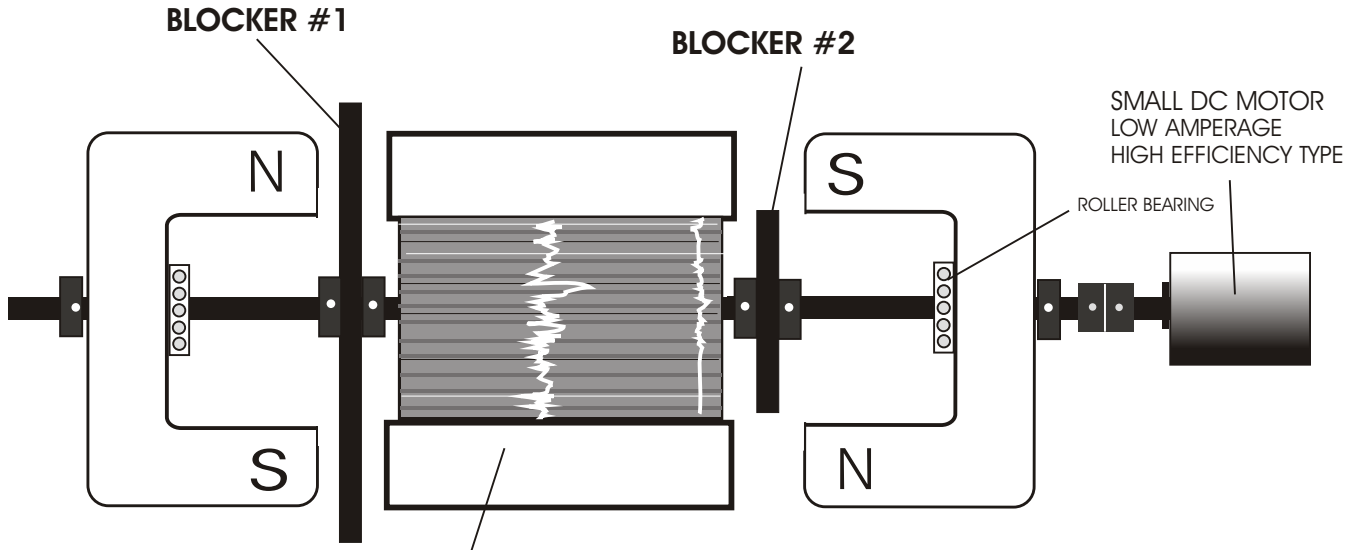

COIL with 1,000s of wraps #30 or #22 copper coated wire with soft iron core or you can use Ductal # 65-4512

Use Very Powerful Ceramic Magnets, Horse Shoe or Bars

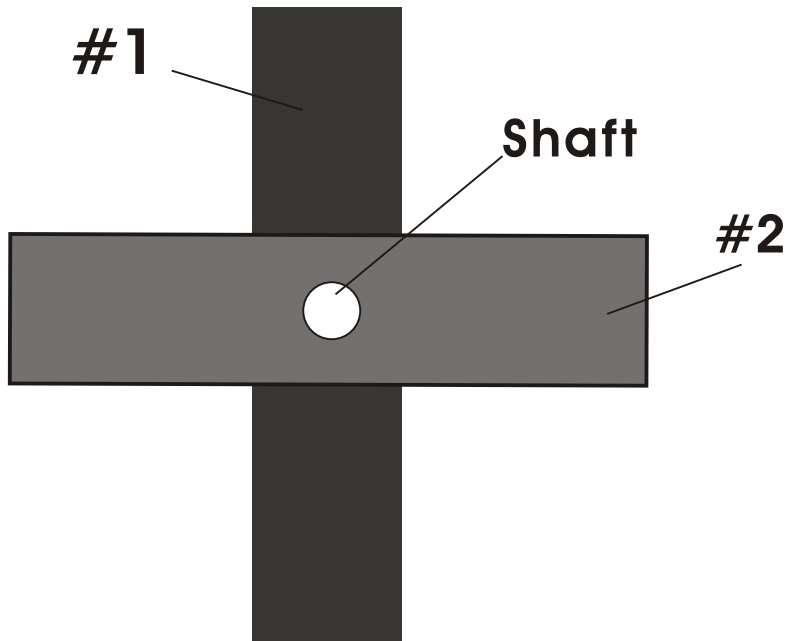

Blocker tops must be 1/8" or more past the magnet on both sides. also blockers must be no less than 3/16" thick, 1/4" is best.

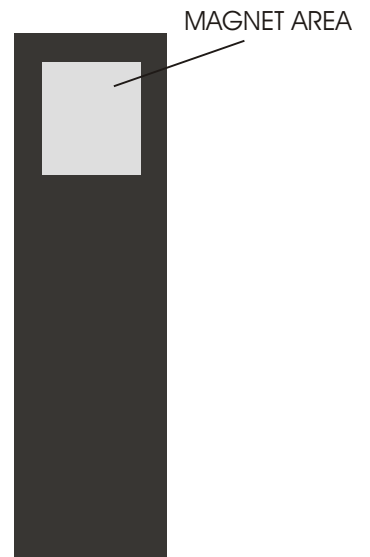

FRONT VIEW OF BLOCKERS AS CONNECTED ONTO SHAFT

Or Try This Design

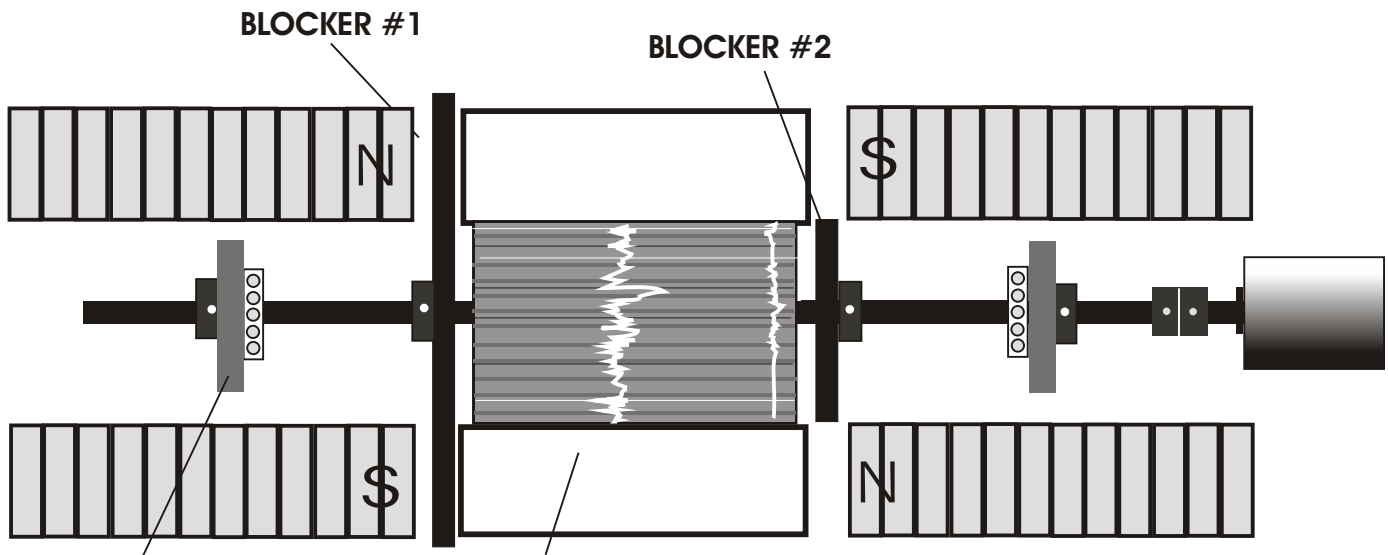

Shaft Support Bar

COIL with 1,000s of wraps #30 or #22 copper coated wire with soft iron core or you can use Ductal # 65-4512

Very Powerful Ceramic Magnets, Bar Type stacked.

Suppliers

Ductal bar # 65-4512 ; Industrial Tube & Steel
1303 Home Ave
(800) 332-9567 Akron, Ohio 44310
(213) 633-8125

Copper Coated Wire
Large Spools Of; Electrical Insulation
(502) 636-0384
Louisville, KY.

Magnets; Magnet Sales & Manf.
11248 playa court
Culver City, CA 90230
(800) 421-6692

BAR MAGNET AREA



Blockers

Objective; To Make blockers and shaft as light weight as possible, To reduce the resistance. (see front on plans Blocker #2 is pulled up in the vertical position because of the magnet.

So if blocker #2 is being pulled into the vertical position by the north and south poles of the magnet it is free energy helping to overcome the lock position that #1 blocker is in. so there is two outside forces helping the #1 blocker move out of the vertical lock position because of blocker #1's magnet attracting to the iron in blocker #1 and that is blocker #2 and the small hp dc motor.

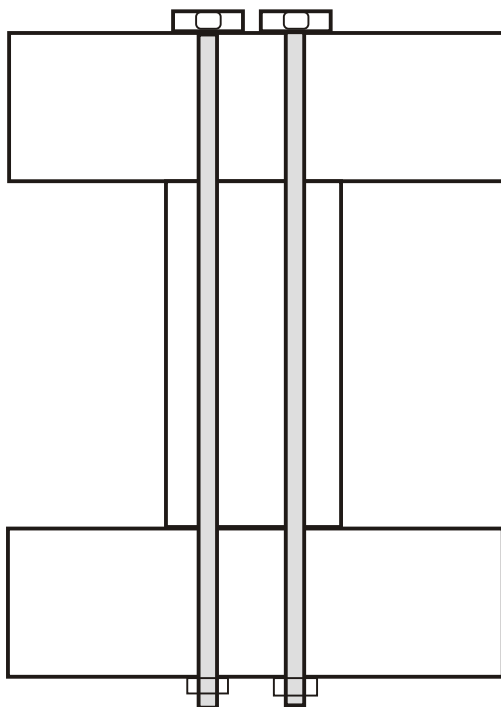
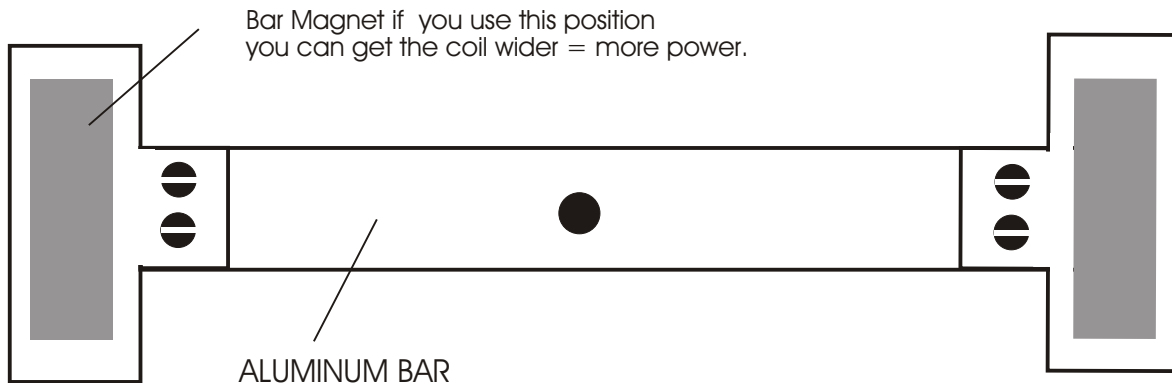

Iron Core

Iron core can be cut out or pieced together as so; with the use of long bolts. drill holes into center of core. Iron core can be made of soft iron; laminated or solid. another iron source to use is solid DUCTAL # 65-4512 WHICH YOU CAN BUY AT; Industrial Tubing & Steel 1-800-332-9567

Be sure to Paint core with enamel then Plastic coat with solid type or liquid type you brush on. it need not be to thick or to thin since we are only using 12 volt to 120 volt ac.

Blocker Experiment

The Objective of this Experiment is to show you that indeed the iron blocker does work. The magnetic field will follow the shortest path it attracts to the iron and only about 3% of the field gets thru (we are guessing on this ?) Use ceramic bar magnets stacked on top of each other, (Radio Shack sells Them also.) use styrene plastic as slip spacer between magnets and iron use 1/4" or 1/2" of card board in between 1/4" iron and coil. Attach your DC volt meter to coil, Hold magnets with one hand, do not let them move at all, or your coil (tape coil down with duct tape or other.) Now quickly pull out the 1/4" iron bar. SEE the voltage it produced? The better you make your coil the higher the amperage and voltage. try different iron etc... remember the more turns of wire you use the more voltage and amperage you will get. Use copper coated wire # 30 or #22 wire try other sizes to find what's best for you.

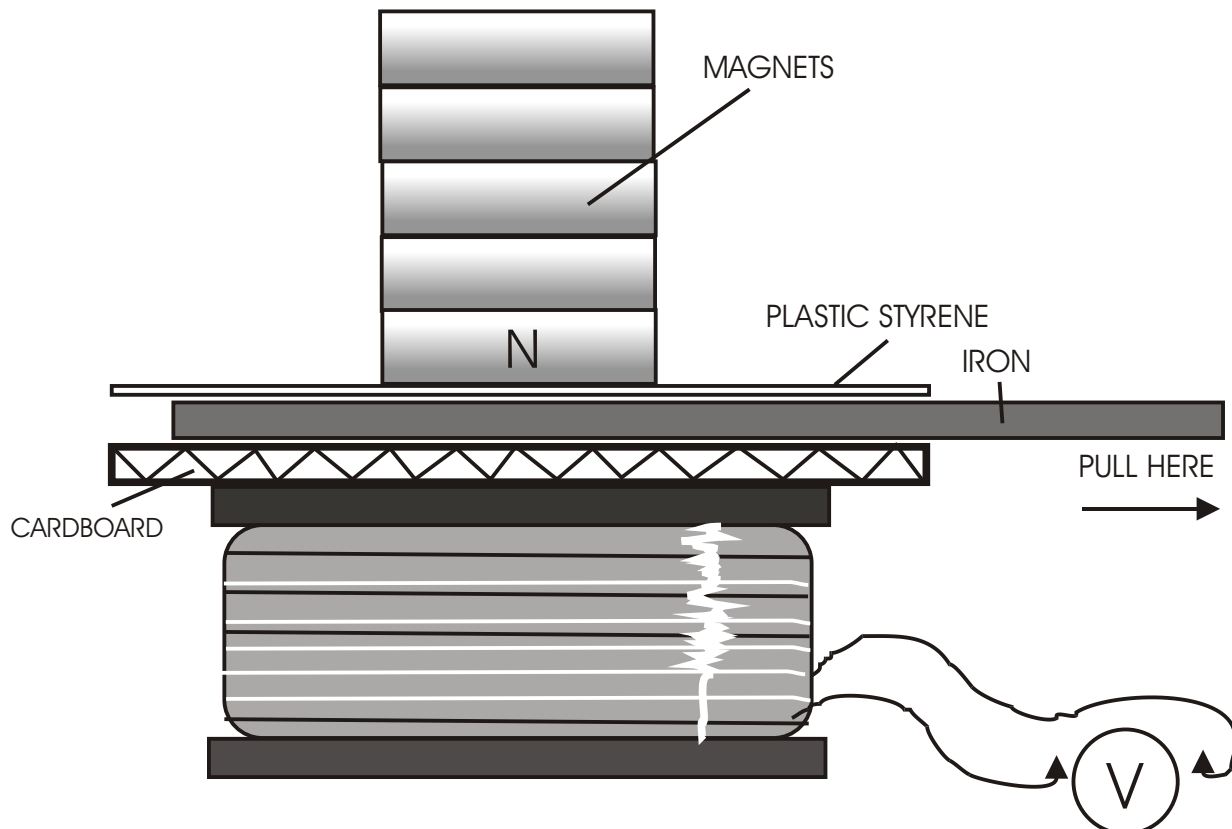

NOTICE: THIS IS THE ONLY TEST WE HAVE YET DONE ON MR. ECKLIN'S CLAIM. BUT EVERY THING SHOULD WORK BY ALL MEANS THE BLOCKER DID. AS SOON AS WE CAN WE WILL RESEARCH THESE CLAIMS MADE BY MR. ECKLIN....

This Generator is said by others to be like no other generator in the world, It was invented by mr. Ecklin and our lab has not fully tested his claim, We have tested the blocker as stated on page 4 and by all means everything should work, We can't wait to finish our other Experiments to test this one out. We feel anyone building this will not waste there time at all.

This generator is claimed to be 50 times more efficient than the generators we have today. stating others: this is the way Gen. should have been made all along. it's a very simple design and it works. the old way to generate electricity is to move a coil of copper coated wire past a magnet or a magnet past a coil of copper coated wire. Since the idea has worked for so many years now, that's the way it always been done and taught, and has been considered sacred ever since. The old way seems to consume about 97% of the INPUT ENERGY! it takes to move the heavy coil of copper wire past the magnets or vise versa.

This method uses way to much resistance or energy to run and is not efficient at all. This generator is the only one that we have not tested yet. our objective at Creative Science is to invent and test and improve any Free energy device and pass the Good ones on to the world.....but very carefully.....

In looking at Mr. Ecklin's Generator, He has made both the Magnets and the Coil Stationary there is no other type like this that we know of. The only moving part is the shaft and the blockers as we like to call them.

Imagine if you will, A very powerful system using high power ceramic magnets and a large array of generating coils or one very large one with 1,000's of turns of copper wire with the blocker shafts being very light weight..so as to generate a large amount of AC or DC electricity... You use a small high efficiency electric motor to turn the shaft which turns the blockers The result is a LARGE OUTPUT OF ENERGY WITH A VERY SMALL AMOUNT OF POWER TO PRODUCE IT..... WITH ONLY A 3% LOSS.....

So that being the case this system should RUN IT SELF! With far more power left over to run your home or a car electric motor.

or a small scale generator can be made to put out 15 volts DC

to always keep an endless charge on a inverter battery system.

(All that maybe needed for such a system would be 2-12 volt deep cycle marine batteries which you can purchase at any K-Mart or other type store. If you do not know what an inverter system is, An inverter system is a system which uses a electronic inverter which alternates the + and - from a 12 vdc battery the out put is 115volts usable house current. let it be noted that you can use a mechanical way of alternating the + & - to create 115vAC by using a small dc motor and build a special disk shaped commuter.)

We tested many blockers and found that steel (with less iron) with a 1/4" thickness worked best. The magnetic field of the ceramic magnets was drawn to the 1/4" steel and only allowed what looked like about 3% field passing thru or around it. We did not have time to test with a meter.

So what the blockers are doing is the same thing a regular generator does. As a magnet comes toward a coil of wire with an iron core there is no magnetic field exciting the coil because it has not reached it yet.....This position would be the same as the blocker being over the magnet and coil... And again in a regular generator...As the magnet moves into the coils field it produces electricity.... This would be the same as our blocker moving away from coil and magnet...The blocker is removed...

We urge you to try this simple blocker test as seen on page 4 of these plans. you will get a much better understanding of what we are talking about this test works very well with our High Voltage Electromagnets, Again if you have a new Free Energy Device Please consider sharing it to the world, We would like the chance to test it and if it works we would like to offer the plans to everyone thru our special Catalog. Or if you have worked on someone else's or know of another device please call or write us. (812) 945-5839
Creative Science New Device P.O. Box 557 New Albany, IN. 47150

This generator is simple in design, You should easily be able to produce 9 KW of ac power, When you use an array of coils or blockers or if you use just one large coil you will get far more better results. Making this generator the most efficient in the world and we hope soon to prove this out, Ist by building a permanent magnet type then a electromagnetic type.

Consider this: What if you combine the Fuel-less Engine coils and capacitor bank with the ecklin and or instead of using blockers what if you used nothing but just simply turning on and off the electromagnets at a high rate of speed, would not this be the same as a blocker? when electromagnet is off that would be the same as the blocker being over the magnet. and with using high volatage dc you get very high magnetism much more than any other permanent magnet or electro magnet and you only use very low milliamps to run it. below is what we have in mind to try. the cap bank could consist of only 2 63v 4,700 uf capacitor per stroke or per array? each array having a delay timer to fire and alternate with the other opposite pole elec. magnet. each array being charged by a low milliamp 3,500 vac inverter, or you can have a lower cap uF hooked in series to add up to 3,000 volts or less, (just enough to fire a very small spark plug, use a small weed eater spark plug or less.) then you can use the spark plugs with your on switches to get the system going.

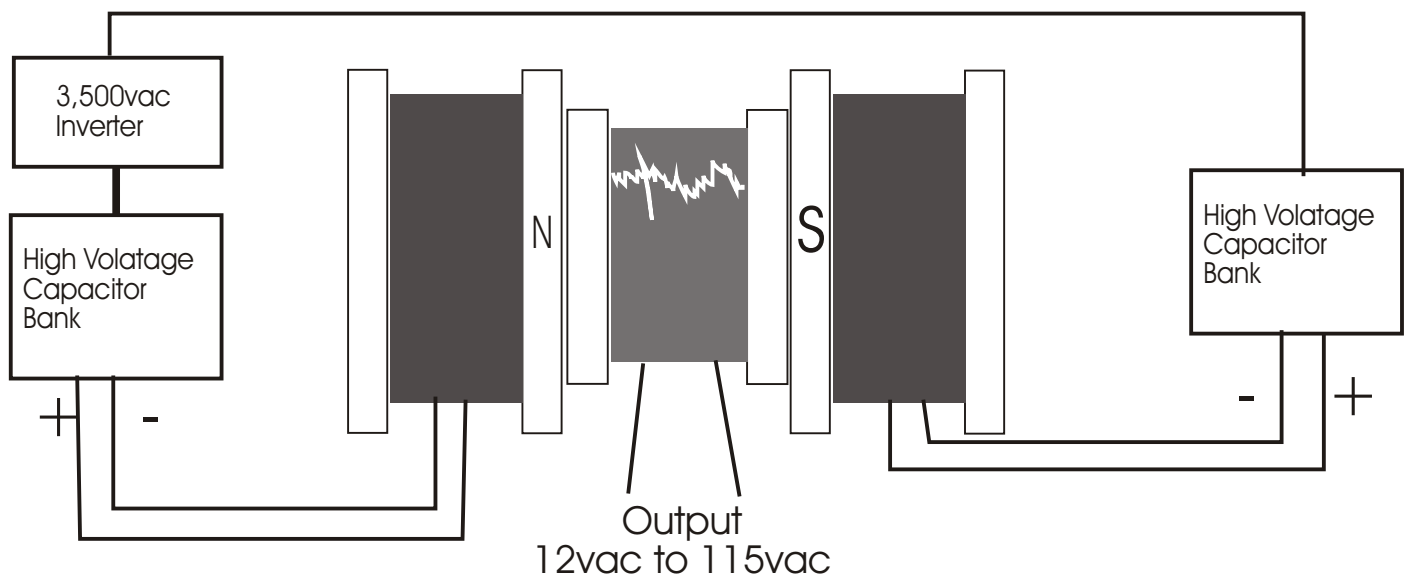

capacitor bank

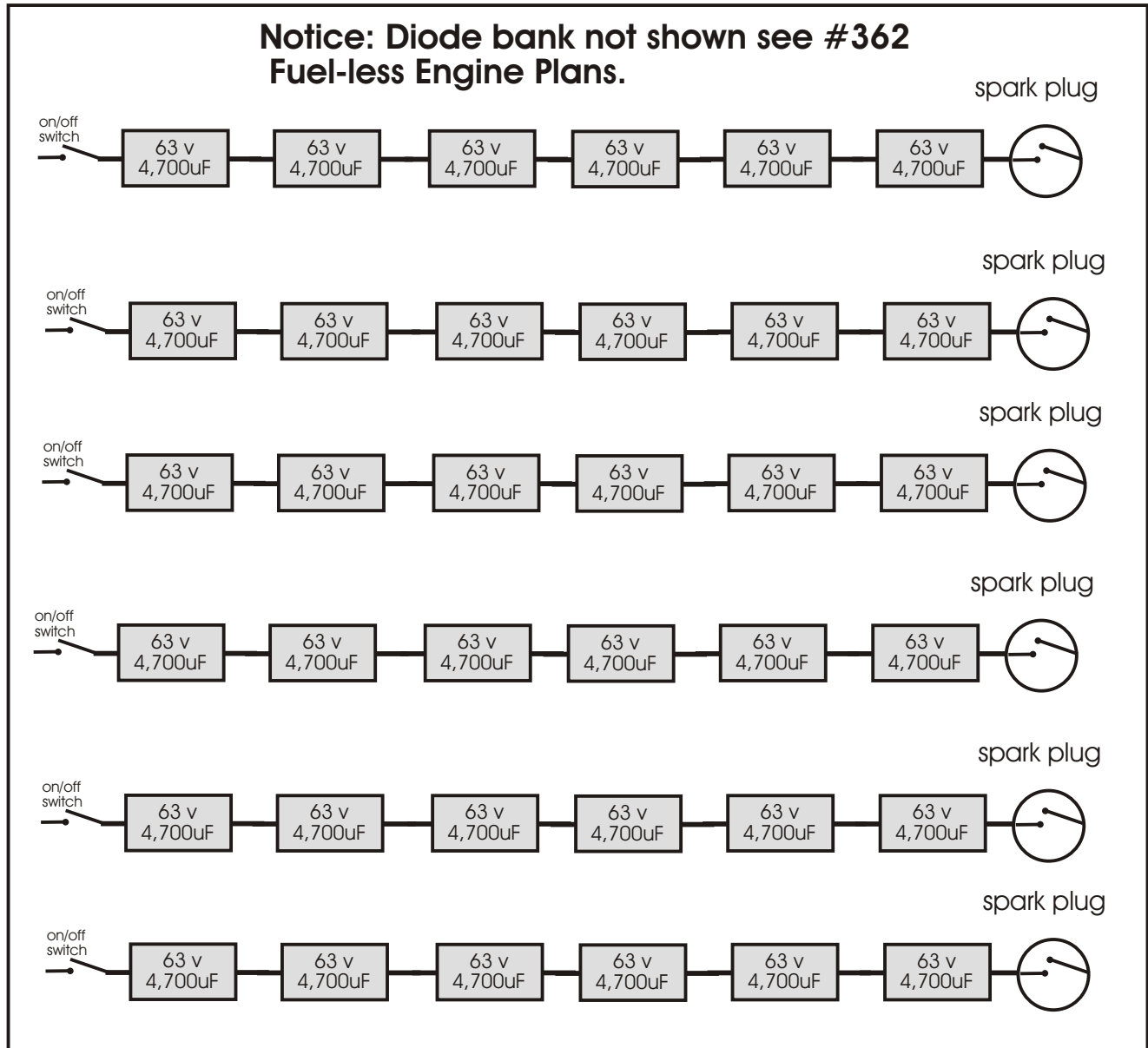

Or could a generator be made without the high voltage cap. system with just using a 12 vdc car battery something like an alternator, BUT WITH NO MOVING PARTS!????
Of course it must be over unity, (To get more out than you put in to run it.....???????)

Note: Again you must see the fuel-less engine plans #362 to understand fully what we are talking about. WE WELCOME ANY NEW SUGGESTIONS OR THEORIES, PLEASE HELP US HELP OTHERS WE ARE LIMITED IN OUR RESEARCH TIME AND MONEY... THERE IS TO MUCH TO DO AND SO LITTLE TIME TO DO IT IN.... PRAY FOR US.

The High Efficiency Generator # Hfg9

Copyright 1996 - 2003 Creative Science & Research

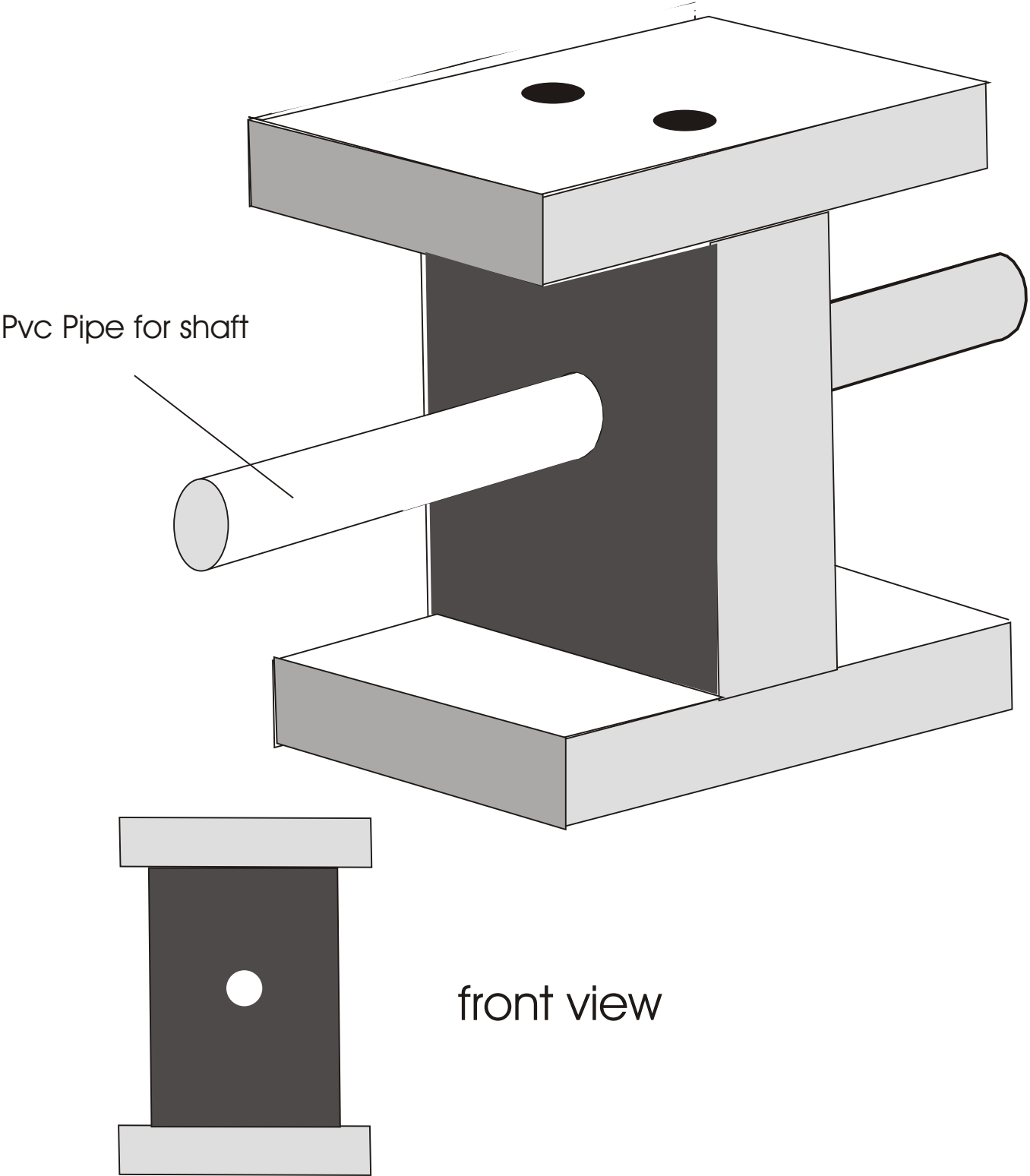

How Blockers Work

#hfg9

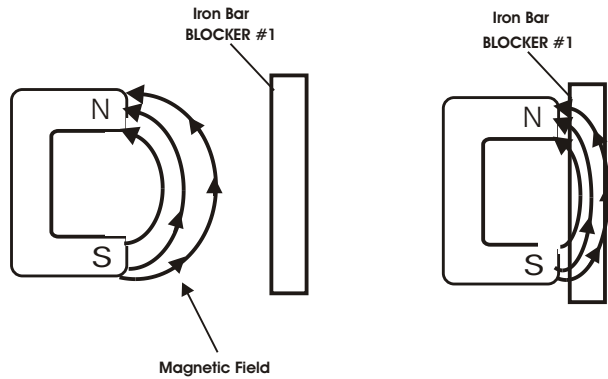

Here is one way of turning off a permanent magnet field. Another way may be to apply a high electromagnetic field which we have tried and it works, but we have not had the time to fully investigate it.

FREE ENERGY AND PERPETUAL MOTION IS EVERY WERE....TAP INTO IT AND LET IT DO YOUR WORK FOR YOU.....

High Speed Wire Wrapper

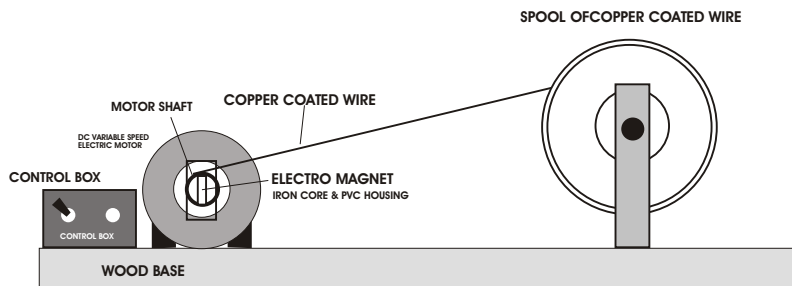

CONTROL BOX CONSIST OF A ON OFF SWITCH AND A VARIABLE CONTROL SPEED SWITCH, IT CONTROLS THE SPEED OF THE MOTOR, THIS IS VERY IMPORTANT AND MUST BE DONE RIGHT. ADJUST CONTROLLER SO IT CAN NOT EVER GO OVER 300 RPM.

SIDE VIEW

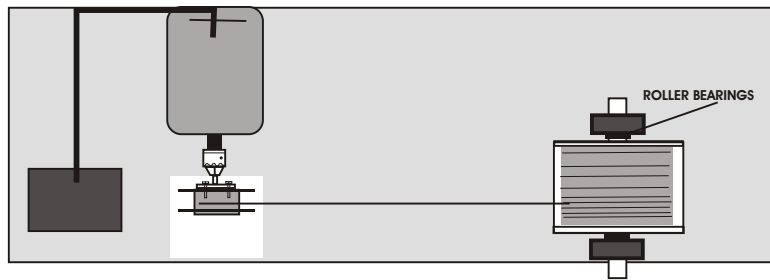

TOP VIEW

Drill bit attachment housing can be purchased separately at any hardware store or you can use an 115vav electric hand drill. for this type of set up you want to turn at about 100 to 300 rpm's.... as you are turning your magnet use your fingers to guide copper wire onto magnet lay the wire in a uniform manner , get each turn as close to the 2nd turn as you can, try not to criss cross allot, you will have a more powerful magnet if you don't criss cross alt. this will require some skill and practice. the better you lay the wire the better the magnet will be. NOTE: The spool shaft must move very freely. the use of roller bearings is suggested but not critical.

The High Efficiency Generator

Hfg9

Copyright 1996 - 2003 Creative Science & Research

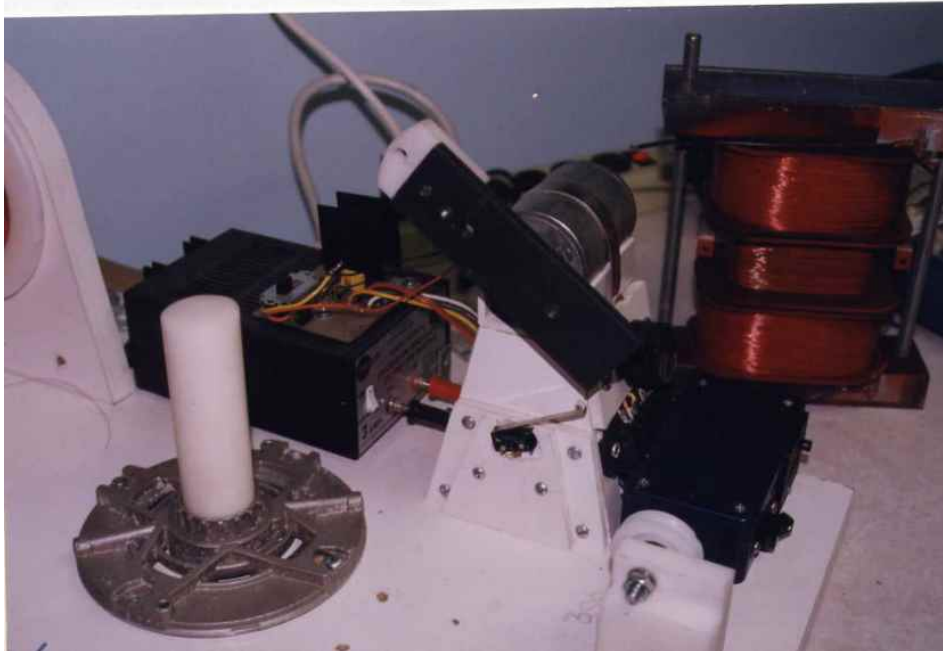
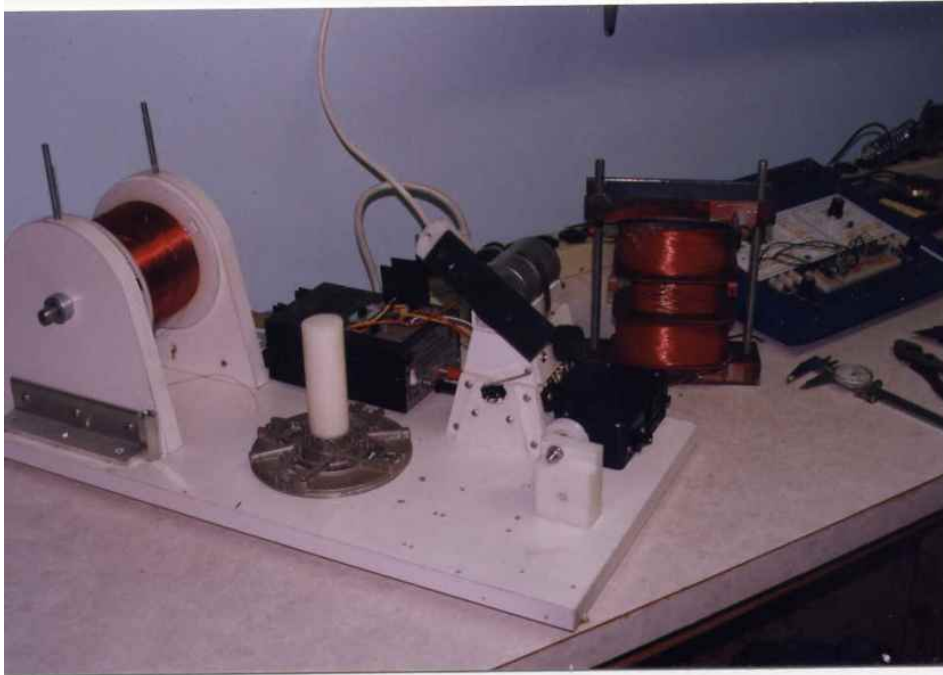

Iron Core -vs- Air Core

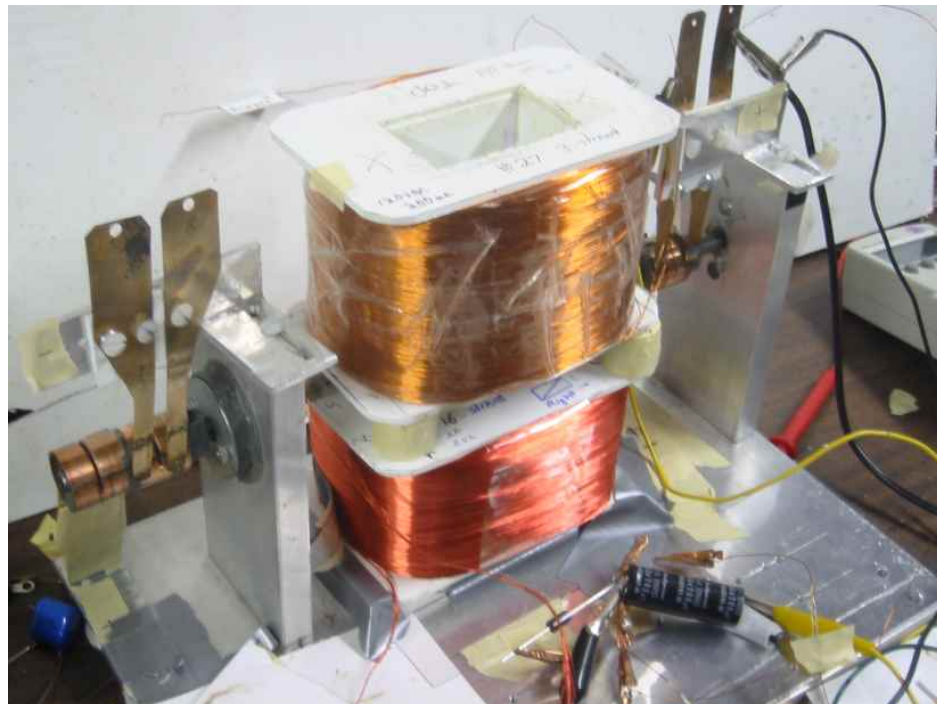
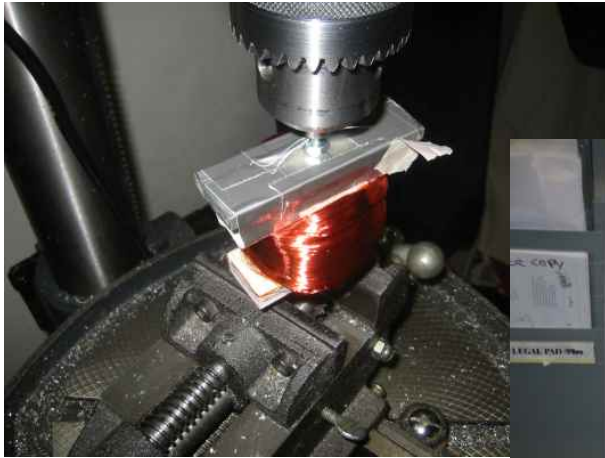

Air Core



This is our Air Core Motor Design which can also be used for HFG9 generator.



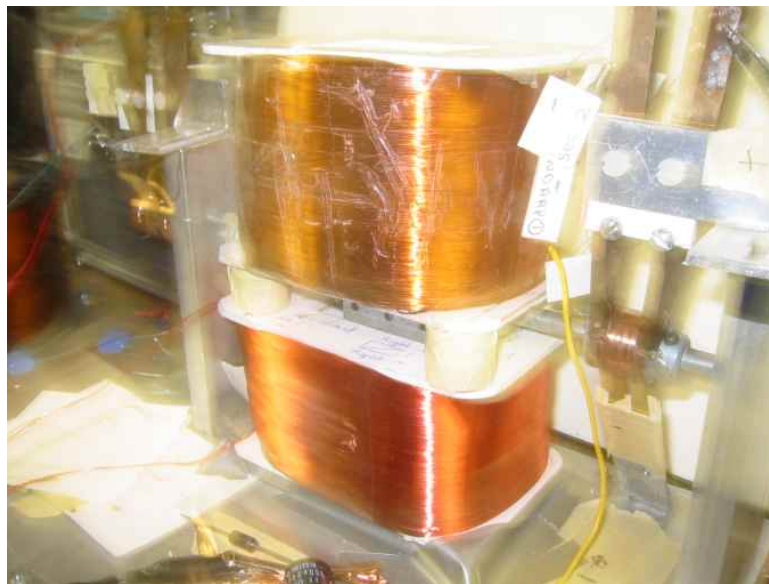

Experiment with many different types of Coils.
Using an amp meter etc. Collect back emf.



An Iron Core Magnet or generator coil,
made from an old wall transformer.