



USING A BIOGAS DIGESTER

Introduction

The use of biogas for day-to-day activities is something that happens on a large scale worldwide. In countries like China and India the waste produced by large factories and households flats etc is being used to produce biogas. It has also helped to reduce environmental pollution.

This document concentrates on small-scale domestic biogas digesters. Our objective is to build awareness on how to properly maintain a small biogas digester and what needs to be done when minor malfunctions occur. The reason being as the result of research carried out suggesting that the majority of biogas digesters become inefficient due to minor malfunctions.

The production of biogas is:

An easy method of obtaining combustible fuel required for domestic consumption though the systematic management of waste.

When do you use a biogas digester?

1. As a substitute for firewood or LP gas used for cooking.



2. As a substitute to the traditional oil lamps used to light the household.

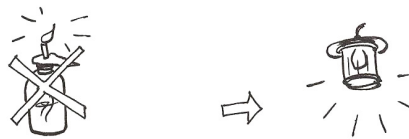

3. If the biogas digester is large it can be used as a substitute for the fuel used to run an engine.



4. As a method of obtaining fertiliser that can be used instead of chemical fertilisers used for cultivation.



technical brief

- To manage waste, which pollutes the air, and transform that waste into something beneficial to the environment.



What are the special advantages of using a biogas digester?

- You do not need firewood or LP Gas for cooking. (This means you need not cut down trees. The environment will be preserved. There is no need to spend time collecting firewood or to spend money on LP Gas. This means it is good for the pocket too).



- You do not need kerosene oil to light the house. This means the money spent on Kerosene is saved. Also, the hazards and dangers of using kerosene are reduced.



- There is no smoke and there is no soot when cooking. This means it is better for your health.



- In the end you receive a very high quality fertiliser (the advantages of using fertiliser is endless. It especially saves money. Apart from this, as you are producing organic vegetables that do not use chemical fertilisers they can be sold at a higher price).

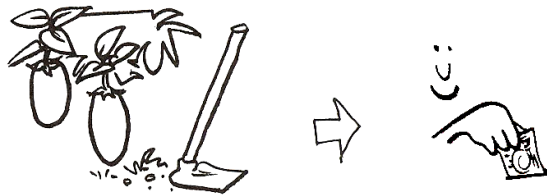

Disadvantages

The initial cost is a little high (but it is very cost effective in the long-term).

technical brief

Introduction to the biogas digester

There are three main types of biogas digesters.

There are:

1. The Indian biogas digester

This is a digester with an expandable gas cylinder or dome. As shown in the picture the waste is being sent and collected from drains on either side. The digester is made using bricks and cement.

The cylindrical dome is made of metal sheets and moves up and down as it stores and releases the gas.

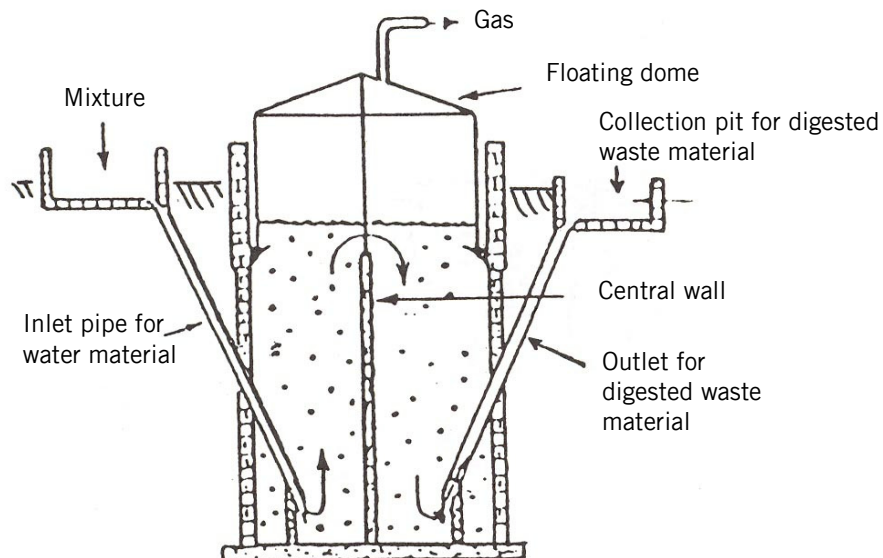

2. The Chinese biogas digester

The bio digester and the composter are made together using cement and bricks and it is a permanent structure. The biogas is collected in the upper chamber and the waste decomposes in the lower chamber. Just as in the Indian digester this has two drains to feed waste and to collect the composted waste.

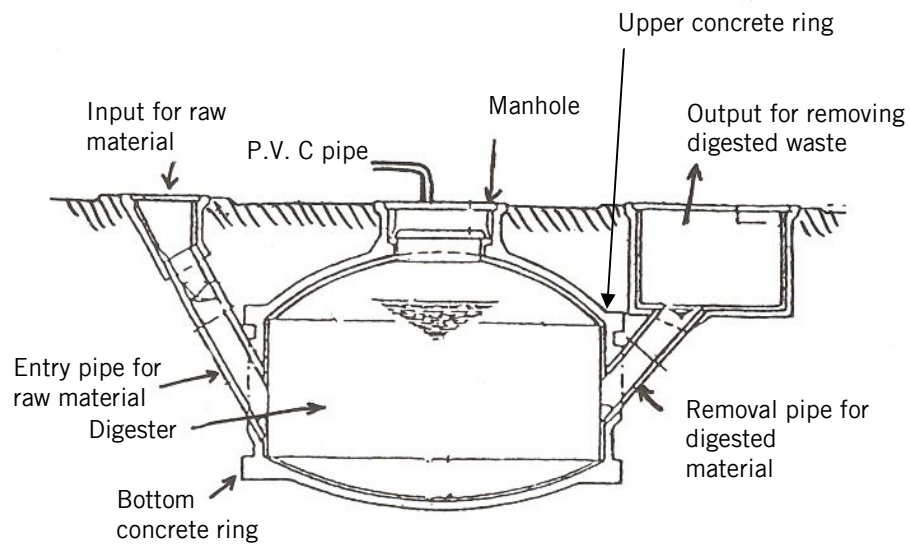

In both the Indian and Chinese digesters the waste needs to be:

Put in daily.



Therefore the best option is to connect the digester to the cattle shed or pigs sty.

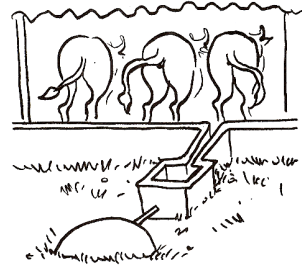

In both methods the toilets that we use daily can also be used to produce biogas. This gives extra sanitation advantages.

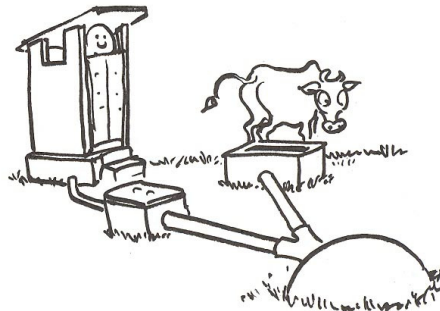

The following table gives the information about the amount of waste that is needed and the output.

The capacity of a digester (square meter)	Raw material (cow dun) Kg (per day)	For cooking (number of people)	The number of lamps that can be burnt
1	25	3-4	2
2	50	4-7	3
3	75	7-10	6
4	100	10-12	8

Sri Lankan biogas digester

This is a novel method identified by the Sri Lanka National Engineering and Research Institute. It also won the silver medal at the International New Developers contest held in Geneva, Switzerland, 1996. As shown in the picture the cylinder is made using brick and cement. The cambers used to collect the biogas are made of low-cost 45 gallon barrels, which can be bought from a normal market. As shown in the picture these barrels are kept separately and connected with air pipes.

The raw material (hay, grass, seaweed, waste from the markets etc) is added and waste is collected by removing the cap on the top.

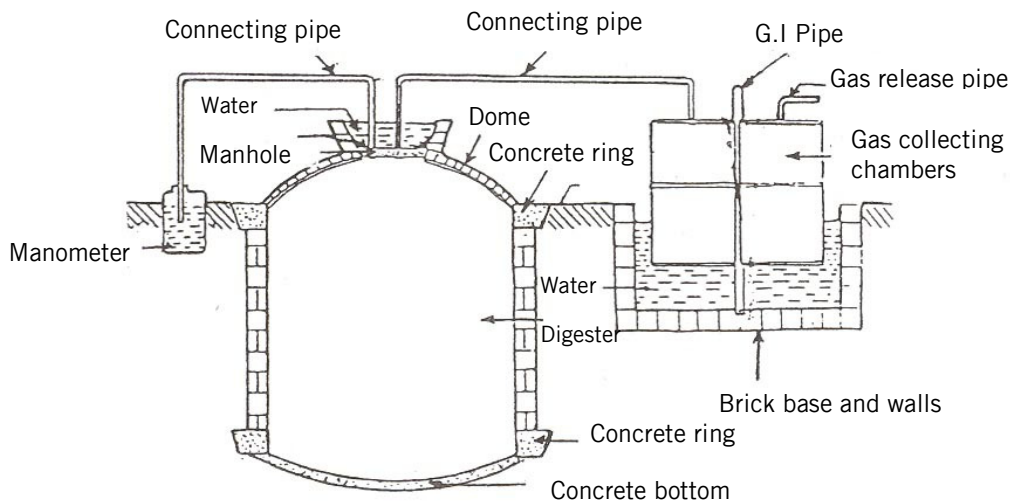

The special advantages of the Sri Lankan bio-digester

- When filled, biogas can be obtained for about 5-6 months.
- Therefore there is no need to add the raw material daily
- The main raw material is hay, which is abundant in Sri Lanka and is commonly burnt.
- Additionally, waste vegetables from markets (market waste), aquatic plants and other grass can be used. Even some factory waste can be used.
- The remaining waste is organic manure full of nitrogen.
- This is an environmentally friendly method of generating energy and helps in the process of recycling waste that is otherwise a threat to the environment.

In using a bio-digester.

- The cylinder of biogas should be covered with soil (then it is possible to protect it from external hazards).

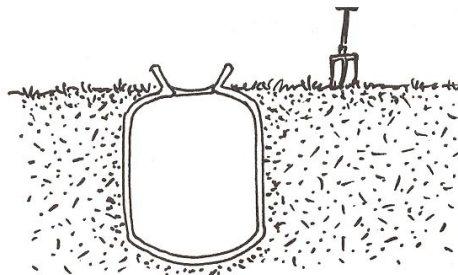

- Avoid planting large trees near the biogas digester (the camber can be damaged by the roots of the tree).

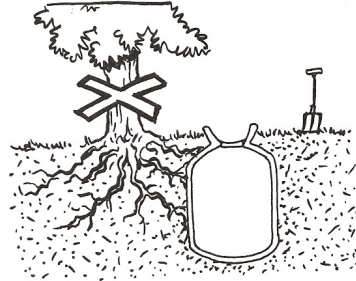

Adding the raw-material

(Only in the Indian and Chinese methods)

- Avoid heavy inorganic material such as stones, soil and sand getting into the cylinder (If the above materials get into the digester, they will collect inside the digester and reduce the capacity and therefore reduce the amount of biogas produced).

How to avoid heavy stuff getting into the digester

- a) By constructing the cylinder used to put in the raw material as shown in the picture. The unnecessary heavy material will remain in the bottom.

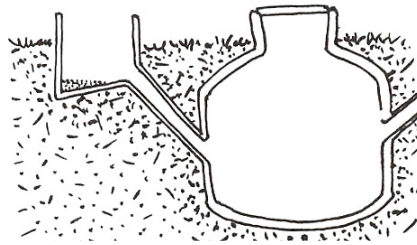

- b) The liquid raw material can be mixed separately and then added to the digester.

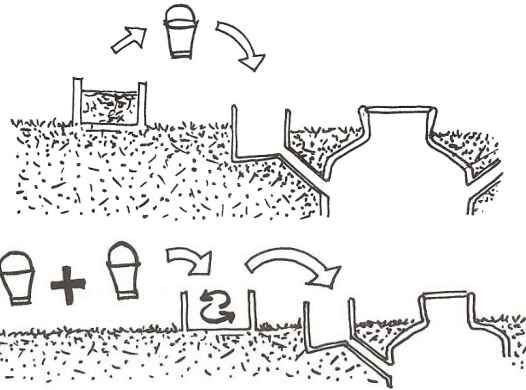

1. The animal waste and water can be mixed in a ratio of 1:1 and put into the digester (one bucket of water to one bucket of cow-dung).

2. Avoiding unwanted material (polythene, grass, paper, wood, etc) getting into the digester.

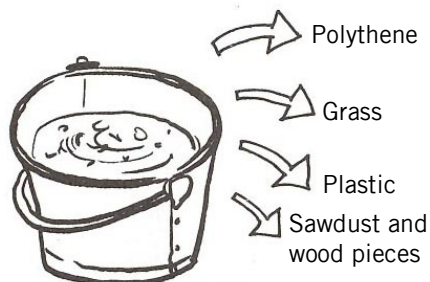

In order to assist the process of removing waste from the digester:

1. Keep the outlet pit clean
2. Remove the digested waste on time
3. Clean the pipe that filters the digested waste, at least once a month.

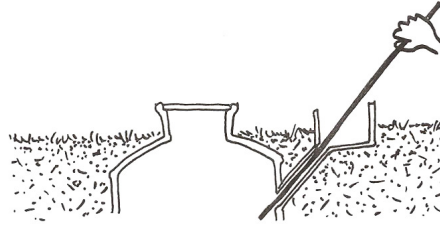

About the air pipe

1. Observing whether air is leaking from the pipes.

If there is any suspicion of the air leaking from the pipes, check it by applying soapy water to that section. If it shows that the air is leaking from that section you should act immediately. If you are burying the pipeline under soil, you should be extra careful.



2. By adding a tap near the digester, you can avoid the gas being released unnecessarily, especially during the night.

Water drops collecting in the gas pipeline

There can be a few drops of water from the gas. These will collect in the pipe at the lowest points. There will then be problems in getting the biogas to the kitchen.

The water drops will then need to be removed, and this can be done using one of two methods.

- a). If there is a tap attached to the pipeline, in order to remove the water then use this tap.

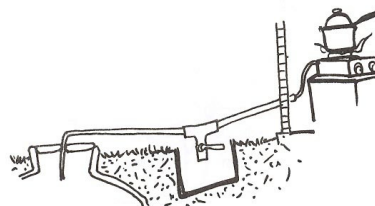
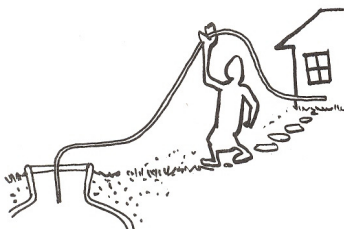

- b). When the pipeline is not buried under the soil, you could lift the pipeline towards the digester and let the water fall back into the digester.

technical brief

In using slurry

- This can be dissolved in water and used as a fertiliser.
- It also can be used after drying in the sun. (it can be even sold in packets.)
- If you want to obtain more organic fertiliser, make another tank (about 3 feet deep), close to the tank that collects the slurry. Then connect it with the tank that collects the waste. Add all the waste that is collected from the kitchen and from the garden. This process will increase the amount of organic fertiliser you can obtain.

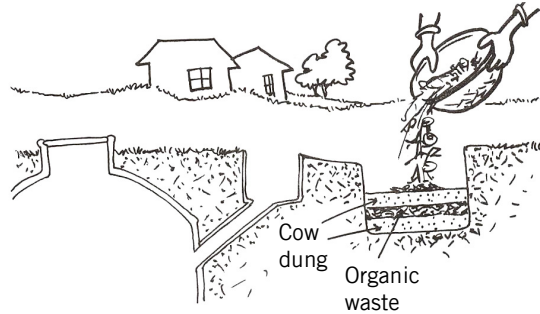

When using equipment that are powered by the biogas digester

The gas cooker

- First light the match and then open the switch (this method will help to reduce accidents as well as save energy).
- Adjust the switch until you get a clear blue flame.
- After cooking, clean the cooker properly. Remove any food particles from the cooker.
- Clean the cooker thoroughly, removing all parts, at least once a month.

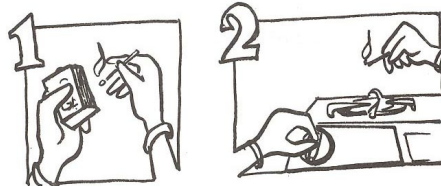

In order to obtain the maximum use of biogas when cooking....

- Use big aluminium pan with large flat bases
- Close the pan with a lid
- Use a pressure cooker as much as possible

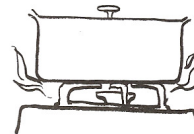

The biogas lamp

It is possible to use a petromax (local lamp) with a mantel for this purpose.

- a. Clean the chimney if it is not clean.
- b. Make sure that the lamp is in a stable position
- c. In this case, light the matchstick first and then open the gas controller and light the lamp.

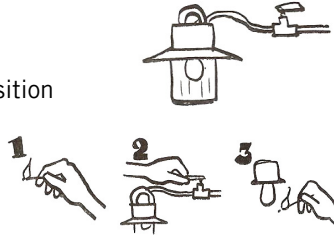

Using the Sri Lankan biogas digester (dry batch unit)

- In filling the biogas digester with paw material
 - a. Collect the raw material (hay and other materials) near the digester.



- b. Collect the required amount of cow dung.



- c. Soak the hay the day before you fill the digester.
- d. Make the cow dung and urea mixture.

- e. Fill the digester with a layer of hay and a layer of cow dung.

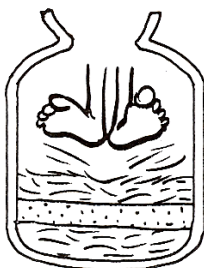
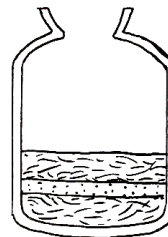

- f. Make sure that the hay is well stacked into the digester. By doing this, it will be possible to stack more hay into the digester and obtain more gas.

- g. Now close the mouth of the digester with a lid with clay (termite mound clay is very suitable for this purpose) to make sure it does not releases any gas. And apply cement on top of that.
- h. Put about 15 cm of water (about 6" or 1/2 a foot) on top of the lid. By doing this it is possible to know if gas is leaking from the lid. (If you like you could even grow lotus or any other water plant in this "pond".)

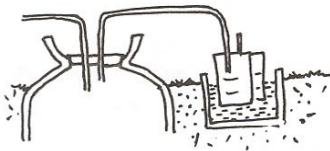
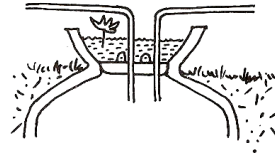

- i. Connect one of the pipes in the cylinder lid with the gas barrels with a clear hose.

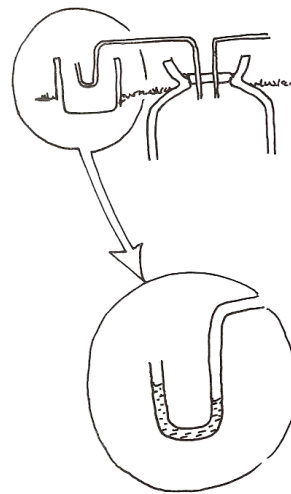

- j. Use a clear hose for the other pipe and make a "U" shape of it and fill it with water. This can be used as a "Manometer". If this is not possible put the hose in a water filled bucket (by doing this, it will be possible to know the pressure inside the digester as well as control it. On the other hand if the gas pressure inside the digester suddenly increases, the excess gas will be released from the pipe, and help protect the digester.

In terms of the air pipes

- Check the water levels in the pits that contain the air pipes.
- Check whether the barrels are floating in the water without any problems.
- Be alert to check whether gas is leaking from the barrels.
- Add some engine oil to the pit. By doing this the rusting of the barrels can be reduced and help to avoid mosquitoes breeding.
- By adding a weight on top of the barrel, the pressure can be increased.

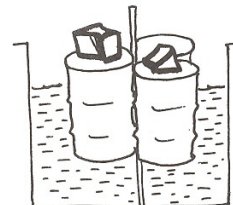
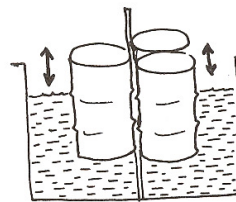

- By applying a coat of paint every six months, the barrels can be used for a longer time.

technical brief

- The maintenance and the use of the other pipe system and the other equipment should also be done in the same manner.

In removing the waste....

- It is best to collect the new raw material before removing the old waste material (then the gas can be re-obtained very quickly).
- Open the lid of the digester; this can be kept open for about two to three days.

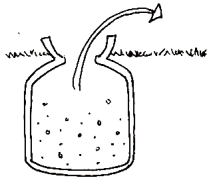

- Afterwards remove all the waste from the pit.
- The black water, which is in the bottom of the pit, can be collected and used as a fertiliser and a pesticide.
- Now refill the pit.

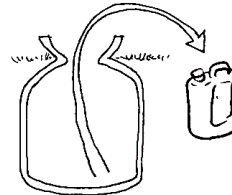
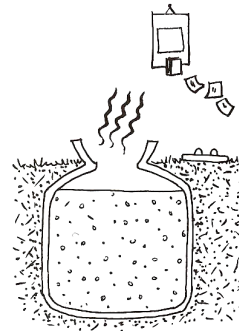
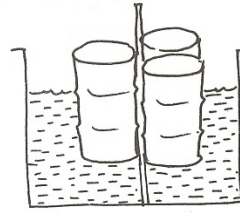

Is there a solution to your problem?

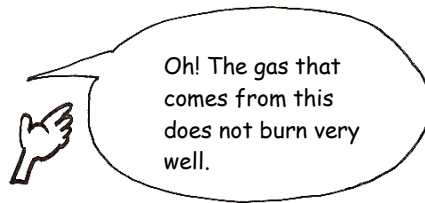

The most likely reason
There isn't sufficient methane; air and other chemicals are getting mixed with the biogas.

Solution
Release the gas allow the gas to be refilled. Then check. (It might be necessary to carry out this activity several times.)

technical brief

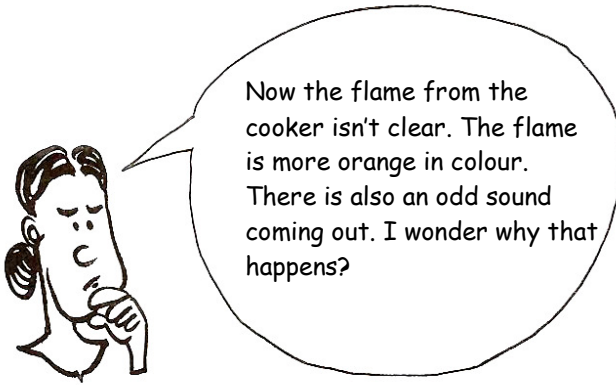

The most likely reason
There might be water trapped in the pipeline.

Solution
Remove the water from the pipe. (Use the methods explained in the previous section.)

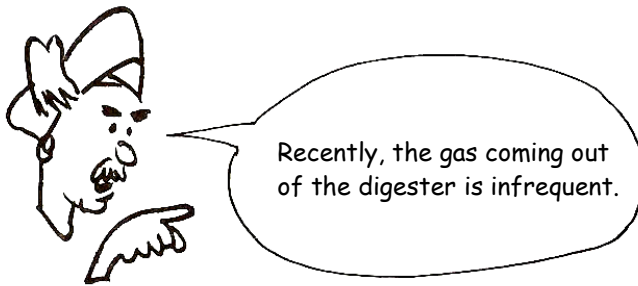

The most likely reason
Water collecting in the pipes

Solution
Remove the water from the pipes

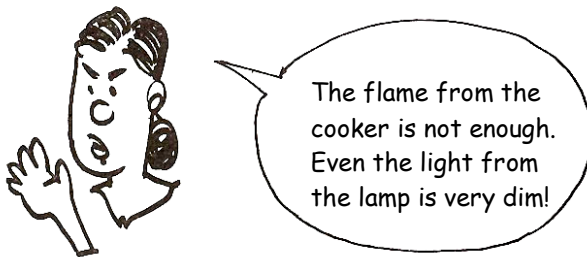

The most likely reason
Not enough gas coming from the digester

Solution
Make the gas nipple bigger

technical brief

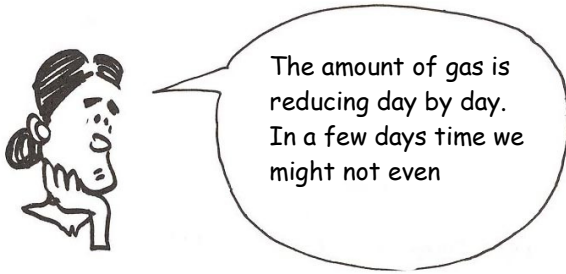

The most likely reasons

1. Gas leaking from the pipe (first check and make sure)
2. Gas leaking from the lid (first there will be bubbles in the water over the lid)
3. **Adding too much or too little raw material (in the Indian and Chinese methods).**
4. Not mixing the water and the raw material properly before adding into the digester (Chinese and Indian methods).
5. The cow dung solidifying inside the digester.
6. Sand and pieces of rock entering the digester.
7. Cracks in the digester, air leaking from the walls of the digester.

Solution

Apply a soap/water mixture onto the areas of concern (the pipe connections). If there are bubbles then correct the problem. After you notice this apply another layer of clay.

Compare the amount that you should put in daily against the amount you currently add. Make sure you only add the required amount of raw material. You should mix the two at a ratio of 1:1 (one bucket of water with one bucket of cow dung).

Remove the lid and take away this material completely.

Remove the lid and check the digester with a stick. If there seem to be a layer of sand empty the digester completely and fill it again.

Empty the entire digester and check this. Getting assistance from your technical advisor is suitable at this stage.



The most likely reasons

The pipe used to enter the raw material is blocked.

The edge of the pipe is getting blocked with sand or small rocks.

Solution

Insert a bamboo stick or a wooden stick and check the pipe.

Open the lid of the digester then clear the pipeline.

technical brief

This document was written by Sanjeevani Munasinghe in Sinhalese and translated by Kanchana Wijesuriya.

The author would like to thank B.W.A Bulathgamuwe, the Field Officer who helped in editing and Rohitha Ananda who helped in the processing of the booklet.

Sanjeevani Munasinghe
Project Manager
Practical Action South Asia
5, Lionel Edirisinghe Mawatha
Colombo5
Sri Lanka
Tel: +94 11 2829 412
E-mail: general@practicalaction.lk

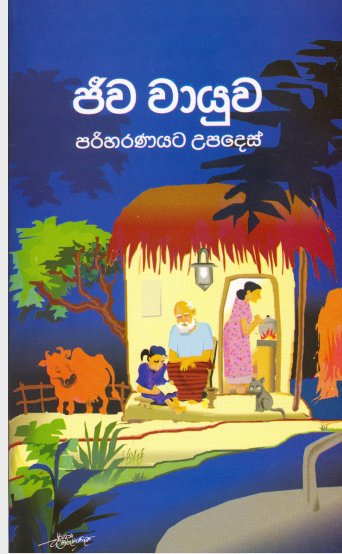

References and further reading

- *Biogas* Practical Action Technical Brief
- *Energy for Rural Communities* Practical Action Technical Brief